

LG-T2727RGBA-TD-A

DATA SHEET

SPEC.NO. : SZ19081205
DATE : 2020/05/07
REV. : A/1

Approved By:

Checked By:

Prepared By:



LG-T2727RGBA-TD-A

TOP Full-color LED

LIGHT

LIGHT ELECTRONICS CO., LTD.

ES

Characteristics

Relative Luminous Intensity VS Forward Current

T_{Ambient} 25

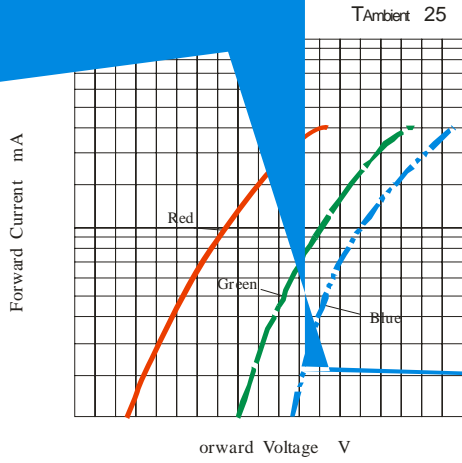

Relative Luminous Intensity

Forward Current mA

Forward Current Derating Curve

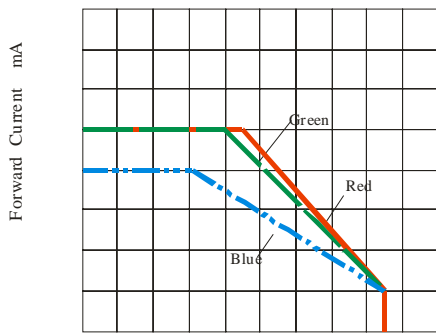

Relative Spectral Distribution

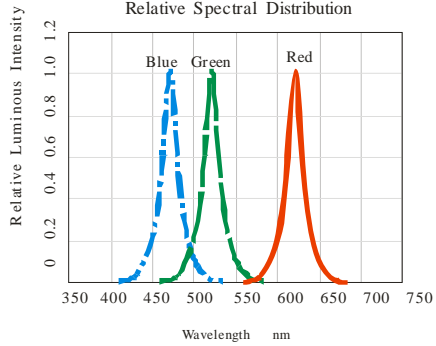

Typical Spatial Distribution

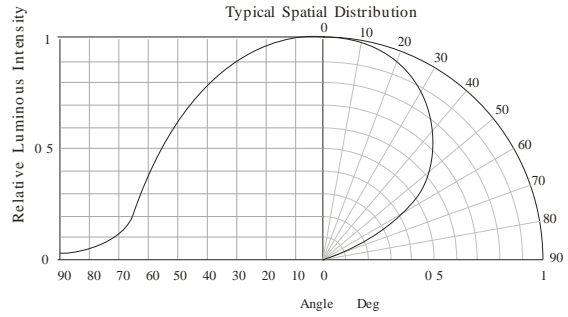

LIG

LIGHT ELECTRONICS CO., LTD.

1

Packaging (1)

◇ Carrier Tape

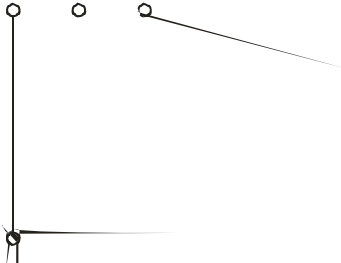

◇ Details Of Carrier Tape

Progressive Direction →

◇ Reel Dimension

Progressive Direction →

Label

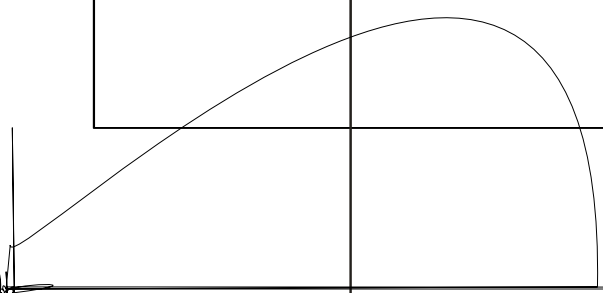

2

Packaging(2)



Moisture Proof and Anti-Electrostatic Foil Bag

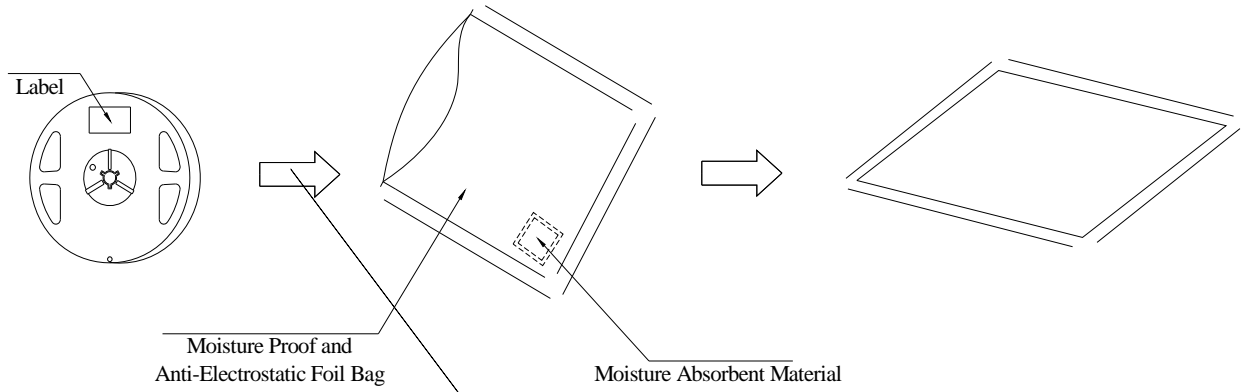

Cardboard Box



Label Explanation

1

Guideline for Soldering (1)

1.

Hand Soldering

- 25 315 3

If manual soldering is used, the use of a soldering iron of less than 25W is recommended. The temperature of the iron must be kept below 315 with soldering time within 3 seconds and each electrode can be only soldered at one time.

- SMD LED

The epoxy resin of the SMD LED should not contact the tip of the soldering iron.

•

No mechanical stress should be exerted on the resin portion by the tip of the soldering iron.

- 40 LED

Handing of the SMD LED should be done when the temperature of environment is below 40 , in case of LED failures caused by thermal-mechanical stress in condition of high temperature .

2.

Reflow Soldering: Use the conditions shown in the under Figure of Pb-Free Reflow Soldering.

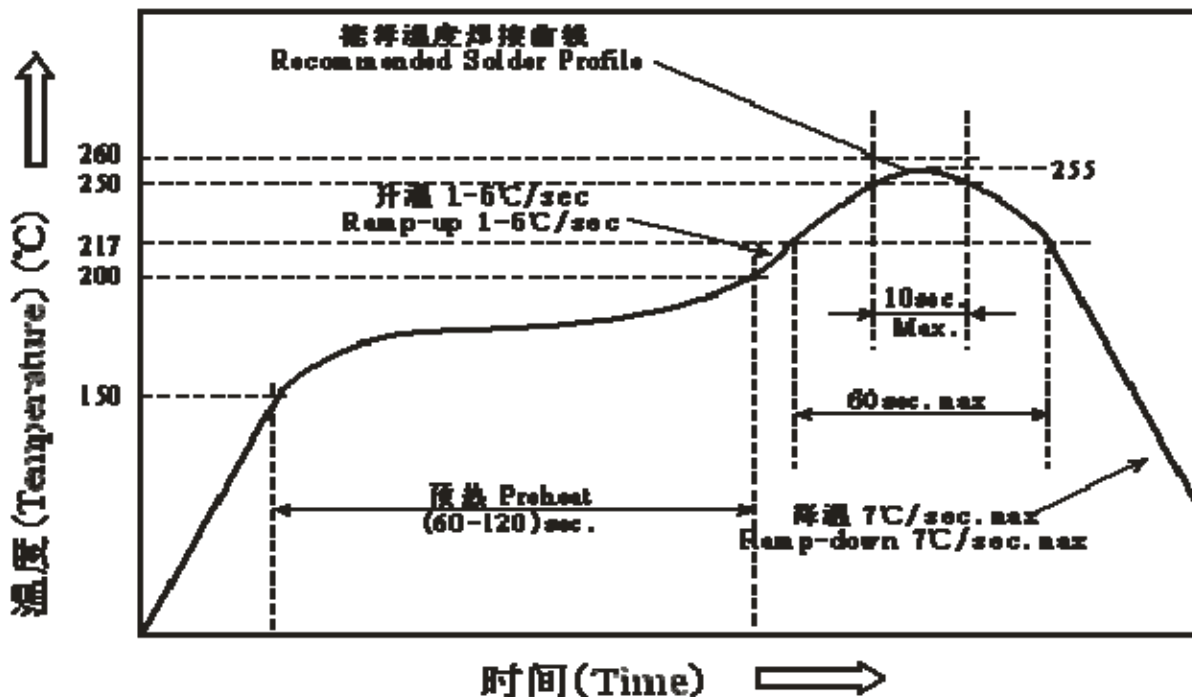

2

Guideline for Soldering (2)

Reflow soldering should not be done more than one time.

LED

Stress on the LEDs should be avoided during heating in the reflow soldering process.



(1)

Precautions (1)

1.

Storage

•

Moisture proof, anti-electrostatic package and moisture absorbent material are used, to keep moisture to a minimum. Humidity indicator card inside to test if the products are moisted.

•

<30 <60 RH

Storage environment: All the products should be stored in the environment of temperature<30 and humidity<60 RH before foiled bags open and need to be baked before SMT.

•

Before using, please check whether there is any air leakage or not, If the bag has leaked air, Please bake the product with below condition.

•

<30 <60 RH 12h

Before soldering ,the product must be stored under the condition of <30 and <60 RH. Under these conditions the SMD LEDs must be used (subject to reflow oven) within 12 hours.

•

70±5 12h

70±5 24h

6 70±5 48h

Baking condition Within 2 months' storage undamped : 70±5 ×12h

After 2 months' storage (undamped): 70±5 ×24h

Damped/Foiled bag leakage/ beyond 6 months' storage at customers' side: 70±5 ×48h

2.

Static Electricity

•

Static electricity or surge voltage damages the LEDs. Damaged LEDs will show some unusual characteristics such as the forward voltage becomes lower, or the LEDs can not be lighted up. In view of the above, we should do some anti-static precautions when using the SMD LEDs.

•

All devices, equipments and machineries must be properly grounded, at the same time we should take measures to prevent anti-static and voltage surge.

•

It is also recommended that anti-electrostatic wrist bands, pads, uniforms, gloves or containers can be used when dealing with the LEDs.

(2)

Precautions (2)

3.

Design Consideration

- LED

In designing a circuit, the current through each LED must not exceed the absolute maximum rating specified for each LED. In the meanwhile, resistors for protection should be applied, otherwise slight voltage shift will cause big current change which will probably lead to damage.

- A LED B
LED V_F LED

It is recommended to use Circuit A which regulates the current flowing through each LED rather than Circuit B. When driving LEDs with a constant voltage in Circuit B, the current through the LEDs may vary due to the variation in Forward Voltage (V_F) of the LEDs. In the worst case, some LED may be subjected to stress in the excess of the Absolute Maximum Rating.

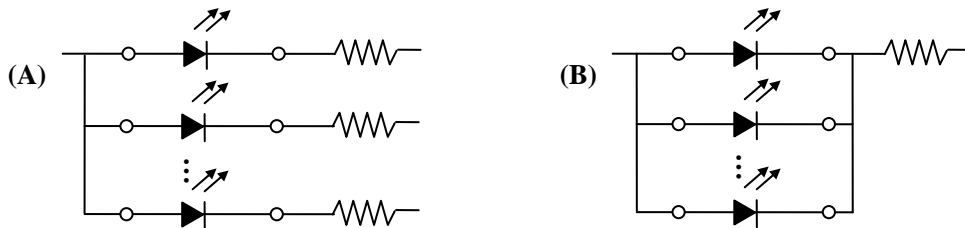

- LED LED

Thermal Design is paramount importance because heat generation may result in the Characteristics decline, such as brightness decrease, Color change and so on. Please consider the heat dissipation when making the system design.

4.

Reverse voltage protection

- LED LED
LED

LED 5V

- In general, the reverse current of LED is very small, which won't affect the normal use of components. But when it is often suffered the reverse voltage which exceeds the limit of the component then it will be damaged.

(3)

Precautions (3)

Such as the reverse current increase rapidly. And it will cause the string light when the screen is black. So please pay attention to controlling the reverse voltage which less than 5V is recommended.

5.

The safe temperature for LEDs working

- LED

55

75

The high temperature will make the LEDs' Luminous Intensity decreased radically, if LEDs are used in hot environment for a long time, they will be disabled easily. When LEDs are used in a high density array, we suggest that the LEDs' surface temperature should be lower than 55 and the legs' temperature should be lower than 75 .

6.

Others

-

When handling the product, touching the encapsulation with bare hands will not only contaminate its surface, but also have an effect on its optical characteristics. Excessive force to the encapsulation might result in catastrophic failure of the LEDs due to die breakage or wire deformation. For this reason, please do not put excessive stress on LEDs, especially when the LEDs are heated such as during Reflow Soldering.

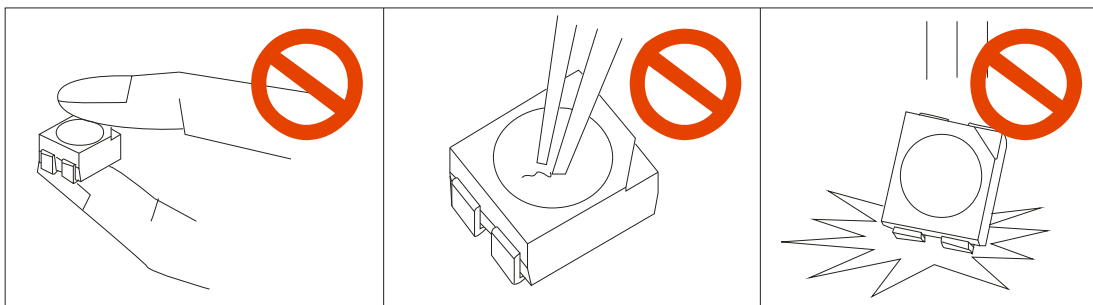

- LED

The epoxy resin of encapsulation is fragile, so please avoid scratch or friction over the epoxy resin surface.

While handling the product with tweezers, do not hold by the epoxy resin, be careful.