

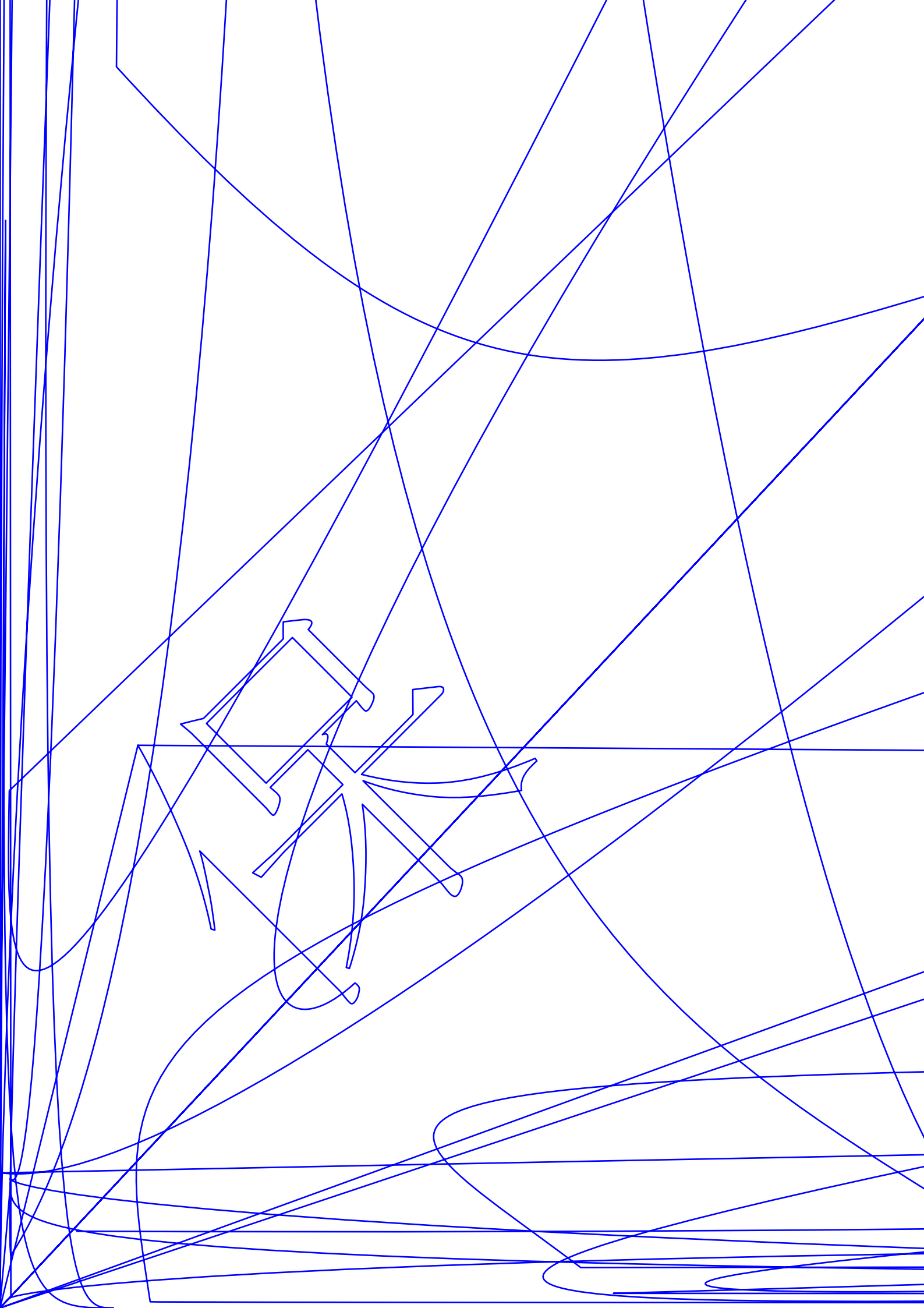

Features

- Pb free product—RoHS compliant
- Low power consumption, High efficiency
- Reliable and rugged
- Long life – solid state reliability
- Viewing angle: 120°

Package Dimension



Typical Electrical / Optical Characteristics Curves for Red (25°C Ambient Temperature Unless Otherwise Noted)

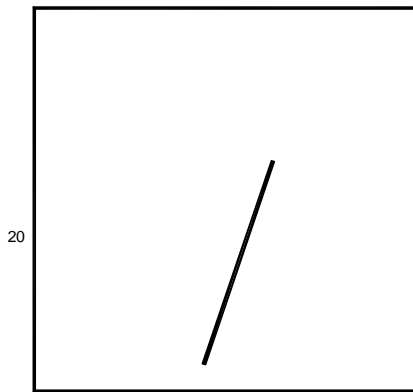

Typical Electrical / Optical Characteristics Curves for Purple (25°C Ambient Temperature Unless Otherwise Noted)

~

(nm)

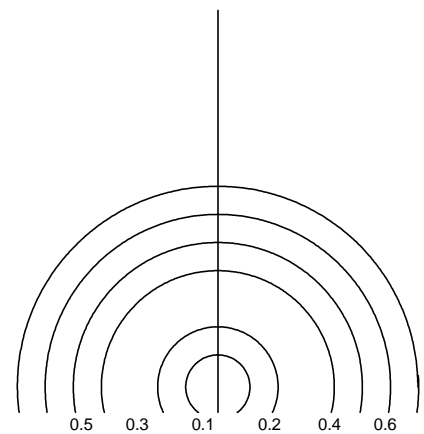
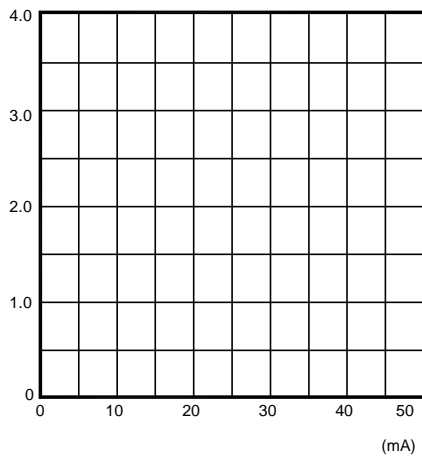
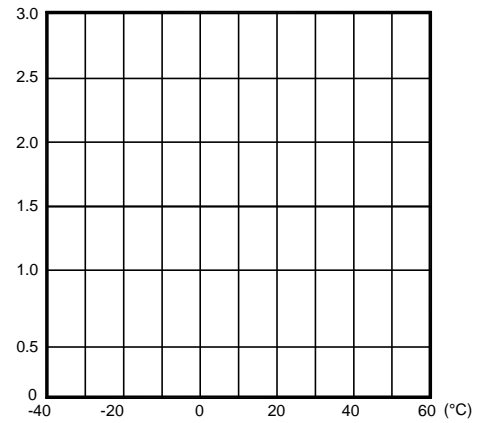
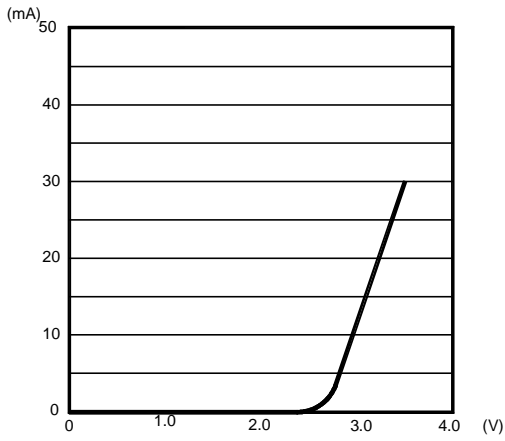

LIG

LIGHT ELECTRONICS CO., LTD.

Carrier Tape Specifications

Moisture Resistant Packaging

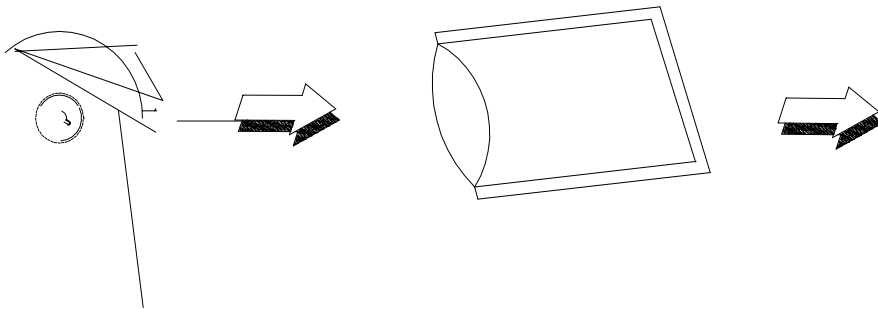

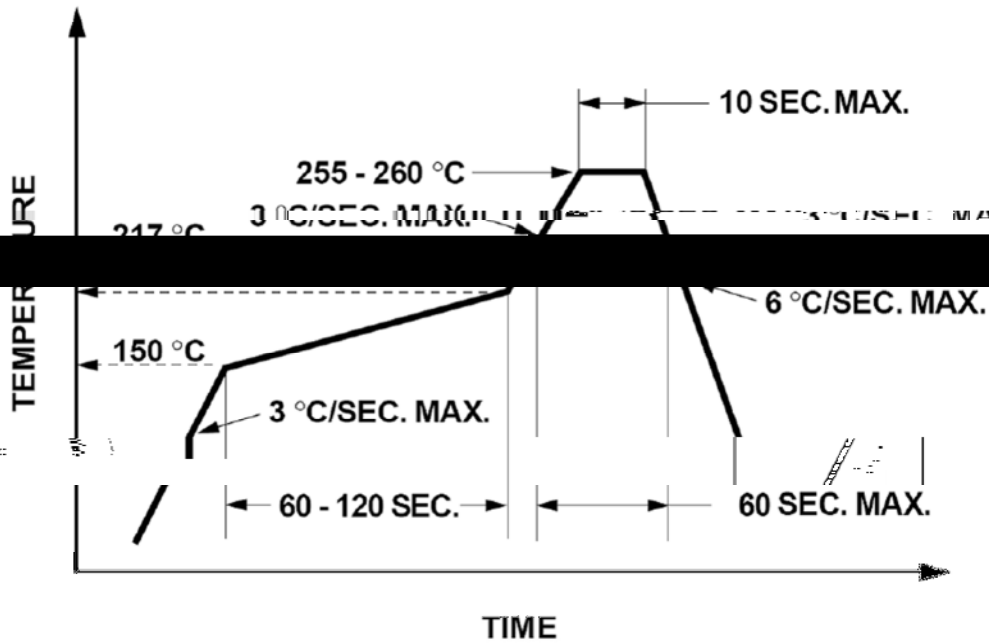

1. Reflow soldering should not be done more than two times.
2. When soldering, do not put stress on the LEDs during heating.

Soldering iron

1. When hand soldering, the temperature of the iron must less than 300°C for 3 seconds.
2. The hand solder should be done only once.

Repairing

Repair should not be done after the LEDs have been soldered. When repairing is unavoidable, a double-head soldering iron should be used (as below figure). It should be confirmed beforehand whether the characteristics of LEDs will or will not be damaged by repairing.

