

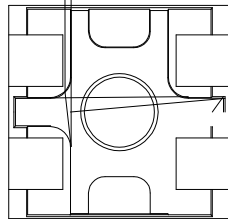

Pb free product—RoHS compliant
Low power consumption, High efficiency
Reliable and rugged
Long life – solid state reliability
Viewing Angle: 110°

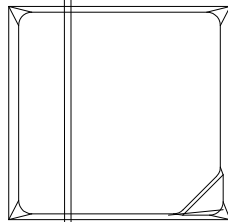

Part NO.	Lens Color	Source Color
SL-T1921SYC020-L190-AL	Water Clear	Yellow

1. All dimensions are in millimeters.
2. Tolerance is ± 0.10 mm unless otherwise noted
3. Specifications are subject to change without notice.

Parameter	MAX	Unit
Power Dissipation	48	mW
Peak Forward Current ^{*2}	60	mA
Continuous Forward Current	20	mA
Reverse Voltage	5	V
Electrostatic Discharge(HBM) ^{*3}	2000	V
Moisture Sensitivity Level ^{*1}	5a	
Operating Temperature Range	-40°C to + 85°C	
Storage Temperature Range	-40°C to + 100°C	
Reflow Temperature	260 for 10 Seconds MAX.	

- (1). Storage requirements before vacuum bag opened: Temperature<30 , Humidity<65%RH;
- (2). Check air leakage and vacuum bag damage before opened. If there is any issue found, check the humidity indicator card immediately after bag opened:
 - a. If color changes on “10% circle” of the humidity indicator card only and not the circles of 20% and above, components can be used without additional handling;
 - b. If color changes on both 10% and 20% circles but not the circles of 30% and above, components must be dehumidified according to the conditions of bullet (5);
 - c. If color changes on 10%, 20%, and 30% circle or above, the product should be returned to the supplier for high temperature dehumidification;
- (3). After bag opened, manual soldering or reflow process must follow the following requirements:
 - a. Complete soldering / reflow within 24 hours;
 - b. Requirements of working environment: Temperature<30 , Humidity<60%RH;
- (4). If the working condition is outside (3)a requirement, the components must be dehumidified according to the conditions of bullet (5);
- (5). Low temperature dehumidification: temperature 60~65 , at least 24 hours;
- (6). Shelf life: 30 days. If it's over 30 days from the production date on the package label, the components must be dehumidified according to the condition of bullet (5). If customer is unable to dehumidify, return components to LIGHT for dehumidification.

Condition for is IFP pulse Pulse Width≤0.1ms and duty≤1/10.

Static Electricity and surge damages the LED. It is recommend to use a wrist band or anti-electrostatic glove when handling the LED. All devices, equipment and machinery must be properly grounded.



Parameter	Symbol	Min.	Typ.	Max.	Unit	Test Condition	
Luminous Intensity	I _v	S12	145	---	185	mcd	I _F =20mA (Note 1)
		S13	185	---	240		
		S14	240	---	310		
Viewing Angle	2θ _{1/2}	---	110	---	Deg.	(Note 2)	
Peak Emission Wavelength	λ _p	---	585	---	nm	I _F =20mA	
Dominant Wavelength	λ _d	Y1	585	---	589	nm	I _F =20mA (Note 3)
		Y2	589	---	593		
Spectral Line Half-Width	λ	---	15	---	nm	I _F =20mA	
Forward Voltage	V _F	V2	1.9	---	2.1	V	I _F =20mA
		V3	2.1	---	2.3		
Reverse Current	I _R	---	---	10	μA	V _R =5V	

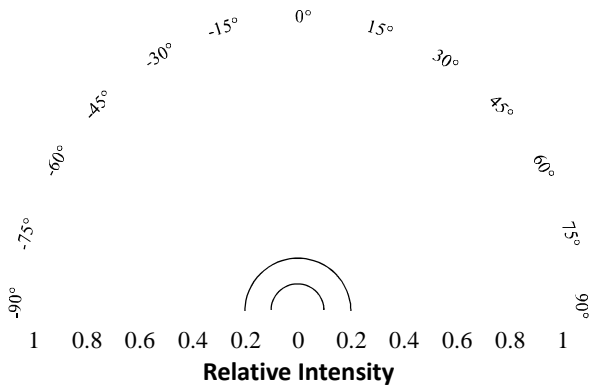

1. Luminous intensity is measured with a light sensor and filter combination that approximates the CIE eye-response curve. Tolerance of Luminous Intensity: ±15%.
2. θ_{1/2} is the off-axis angle at which the luminous intensity is half the axial luminous intensity.
3. The dominant wavelength, λ_d is derived from the CIE chromaticity diagram and represents the single wavelength which defines the color of the device. Tolerance of Dominant Wavelength: ±1.0nm.
4. Tolerance of Forward Voltage: ±0.1V.

°C



Label Explanation

LIGHT	
Light Electronics CO., LTD.	
MODEL NAME: _____	 LOT NO: _____
QUANTITY: _____	
BIN: _____	
PACKING DATE: _____	
REMARKS: _____	

LIGHT	
Light Electronics CO., LTD.	
MODEL NAME: _____	 LOT NO: _____
QUANTITY: _____	
BIN: _____	
PACKING DATE: _____	
CUSTOMER P/N: _____	

Reel Dimensions

Tolerance unless mentioned is $\pm 0.2\text{mm}$; Unit = mm

--	--	--	--

Carrier Tape Specifications(Loaded Quantity: TBD)

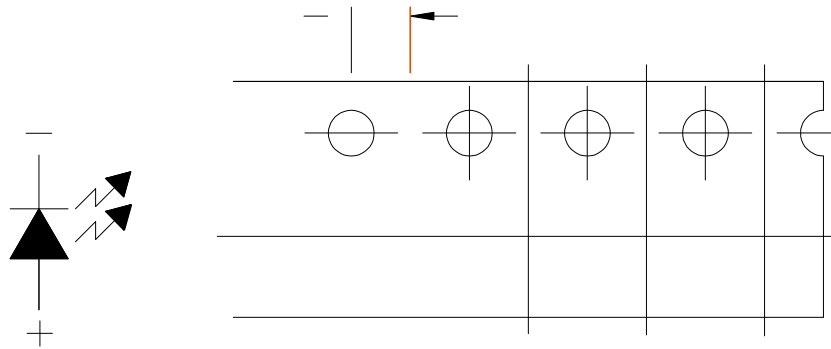

Moisture Resistant Packaging

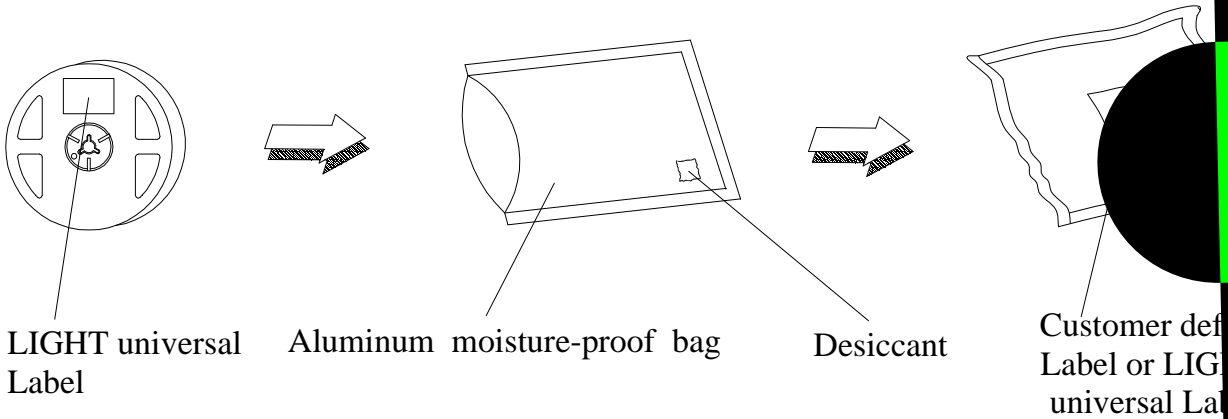

Suggest IR Reflow Condition For Lead Free

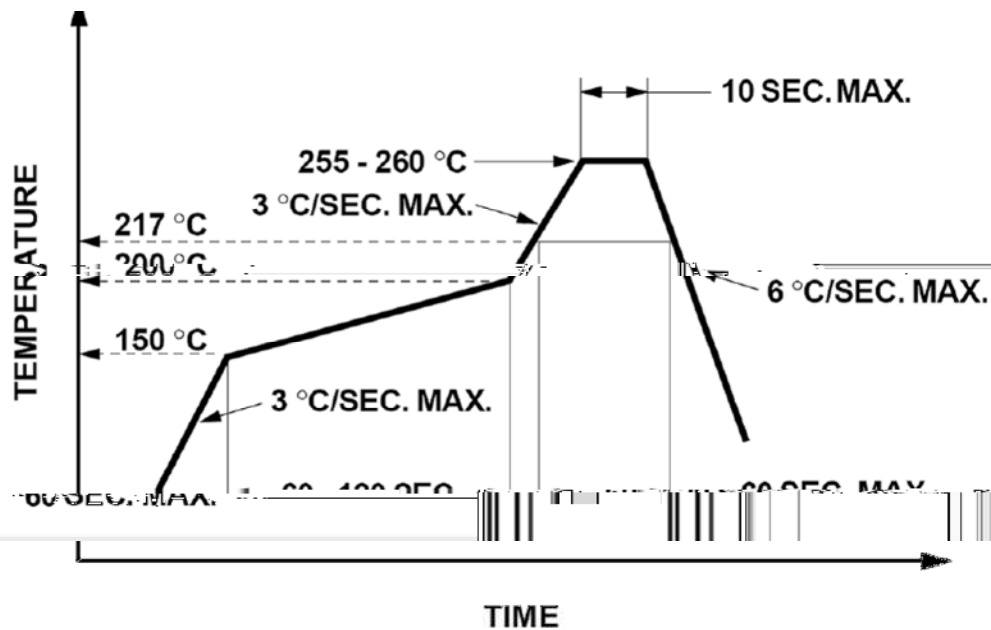

1. Reflow soldering should not be done more than two times.
2. When soldering, do not put stress on the LEDs during heating.

Soldering iron

1. When hand soldering, the temperature of the iron must less than 300 °C for 3 seconds.
2. The hand solder should be done only once.

Repairing

Repair should not be done after the LEDs have been soldered. When repairing is unavoidable, a double-head soldering iron should be used (as below figure). It should be confirmed beforehand whether the characteristics of LEDs will or will not be damaged by repairing.

