

LG-T1921RGBA-TD-AL DATA SHEET

SPEC. NO. : SZ22101501
DATE : 2022/10/15
REV. : A/0

Approved By:

Checked By:

Prepared By:

Catalogue

Electrical Characteristics.....3

Typical Characteri TD(cter)ri TD[35icter

Typical Characteristics Curves

Volt-Ampere Characteristics

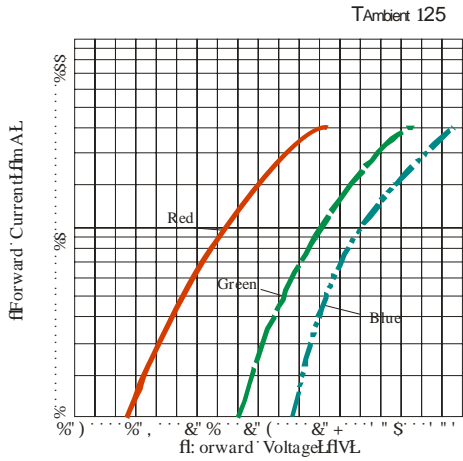

Relative Luminous Intensity VS Forward Current

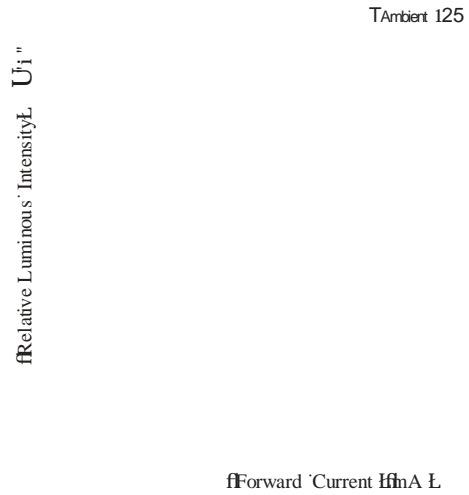

Forward Current Derating Curve

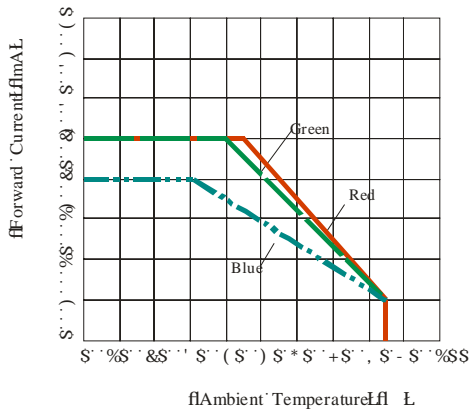

Relative Spectral Distribution

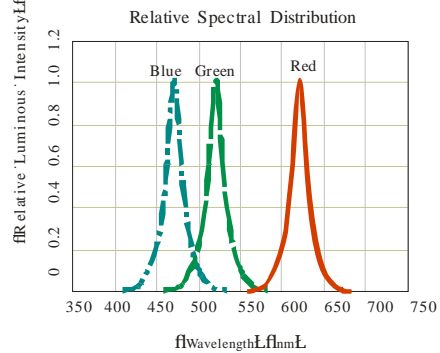

Typical Spatial Distribution

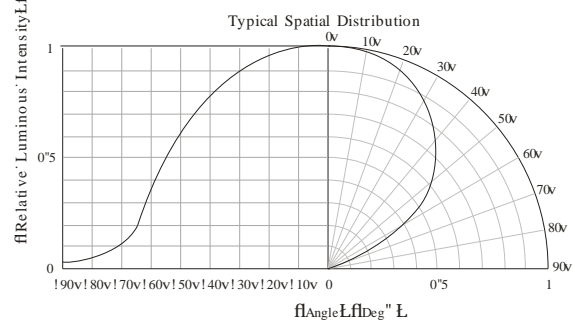

Reliability Test Items And Conditions

实验项目 Test Items	参考标准 Reference	实验条件 Test Conditions	时间 Time	样品数 Quantit	判据 Crite
Thermal Shock	MIL-STD-202G	-40 (30min)←→100 (30min)	300 300 cycles	22	0/22
Temperature And Humidity Cyclic	JEITA ED-4701 200 203	-10 ———+65 0%-90%RH 24hrs./1cycle	10 10 cycles	22	0/22
High Temperature Storage	JEITA ED-4701 200 201	Ta=100	1000h	22	0/22
Low Temperature Storage	JEITA ED-4701 200 202	Ta=-40	1000h	22	0/22
High Temperature High Humidity Storage	JEITA ED-4701 100 103	Ta=60 RH=90%	1000h	22	0/22
Life Test	JESD22-A108D	Ta=25 IF _R =15mA,IF _G =8mA,IF _B =5mA	1000h	22	0/22
High Temperature Life Test	JESD22-A108D	Ta=85 IF _R =15mA,IF _G =8mA,IF _B =5mA	1000h	22	0/22
Low Temperature Life Test	JESD22-A108D	Ta=-40 IF _R =15mA,IF _G =8mA,IF _B =5mA	1000h	22	0/22
Resistance to Soldering Heat	GB/T 4937, .2.2&2.3	Tsol*=260 10sec.	2 2 times	22	0/22

Criteria For Judging Damage

测试项目 Test Items	符号 Symbol	测试条件 Test Conditions	判定标准 Criteria For Judging Damage
Forward Voltage	V _F	I _F = I _{FT}	±10% Initial Data±10%
Reverse Current	I _R	V _R = 5V	I _R 10μA
Luminous Intensity	I _V	I _F = I _{FT}	I _V 30% I _V 50% Average I _V degradation≤30%; Single LED I _V degradation≤50%
Resistance to Soldering Heat			No dead light exists.

* Tsol- IFT * Note: Tsol-Temperature of tin liquid IFT Typical current.

Product design and operational recommendation

1 mm

Product design Unit: mm

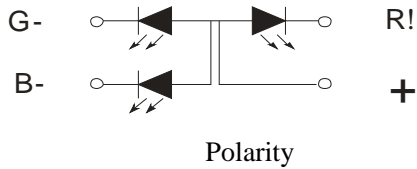
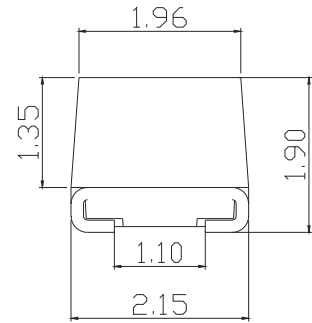
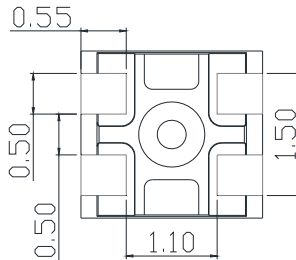
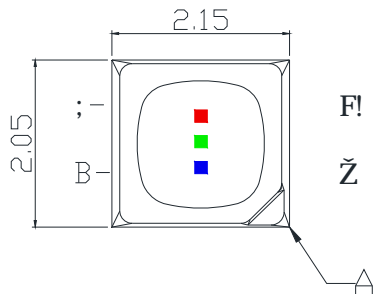

Note

A

A Nick Mark

X.X w0.1 mm X.XX w0.05mm

Tolerances X.X w0.1 mm X.XX w0.05mm

2 mm

Recommended soldering pad (Unit: mm)

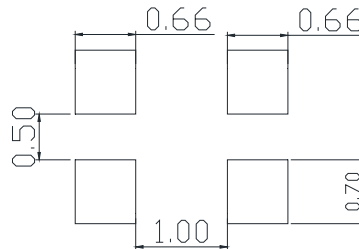

3 0.75mm

Recommendation for glue filling: filling height must be higher than or equal to 0.75mm

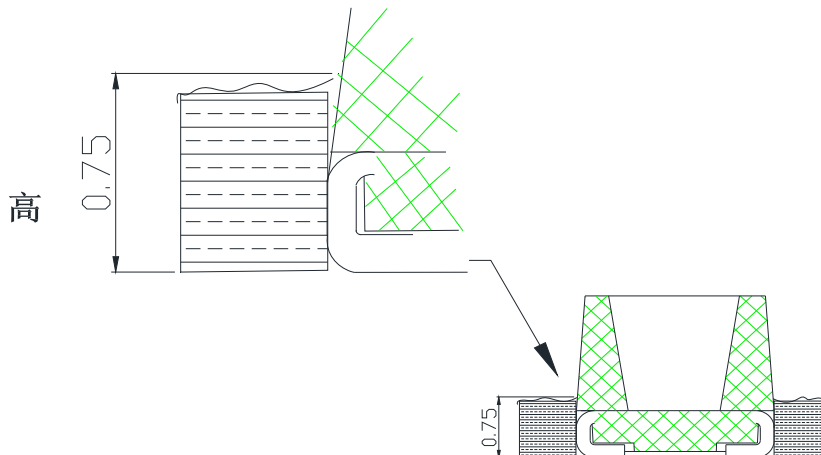

1

Packaging (1)

Carrier Tape

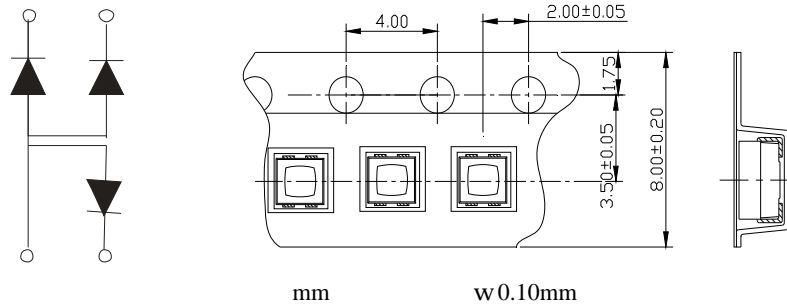

All dimensions in mm, tolerances unless mentioned is w 0.10 mm.

Details Of Carrier Tape

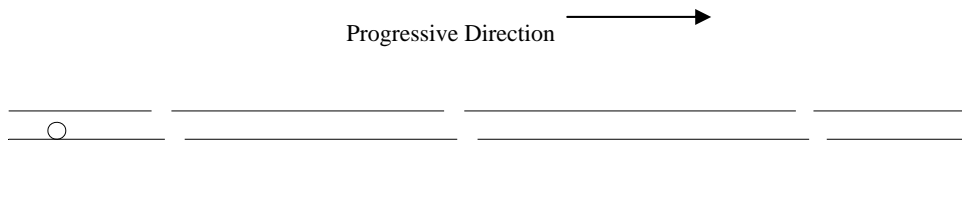

Reel Dimension

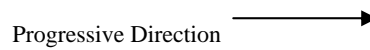

Label

LIGHT

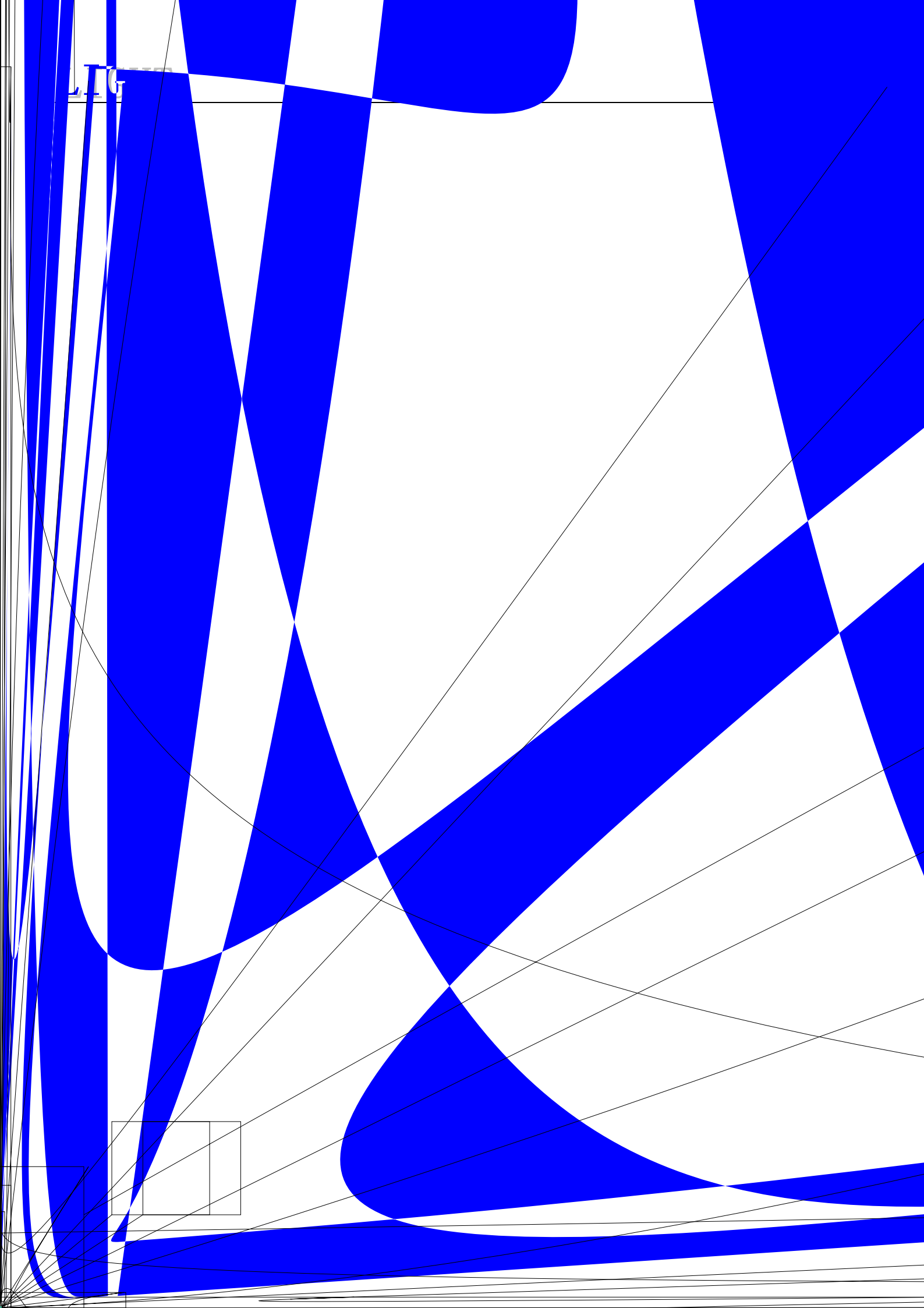

2

Guideline for Soldering (2)

- x ·
- x · Reflow soldering should not be done more than one time.
- x · LED
- x · Stress on the LEDs should be avoided during heating in the reflow soldering process.

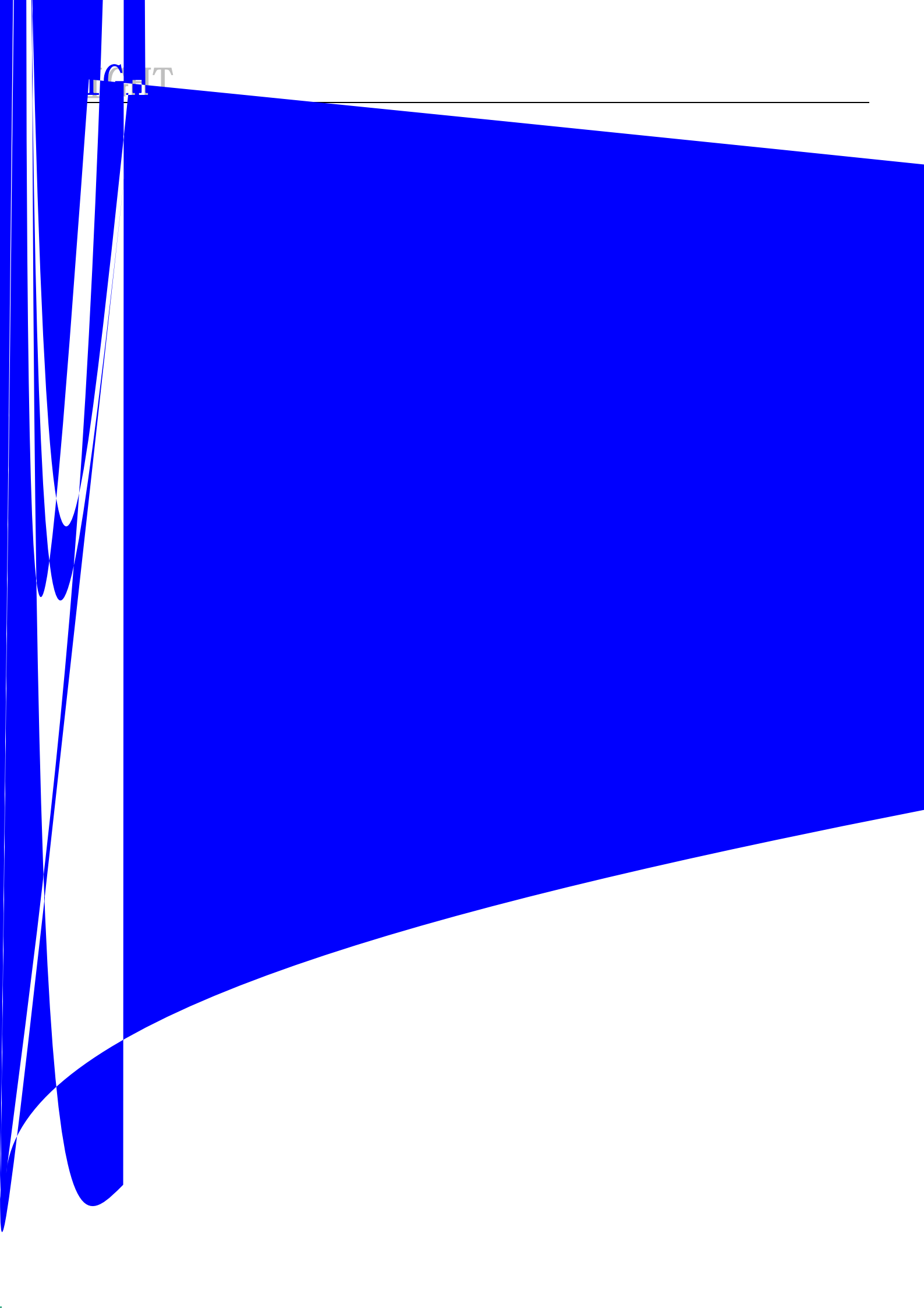

(2)

Precautions (2)

3.

Design Consideration

- LED

In designing a circuit, the current through each LED must not exceed the absolute maximum rating specified for each LED. In the meanwhile, resistors for protection should be applied, otherwise slight voltage shift will cause big current change which will probably lead to damage.

- A LED B LED
LED V_F LED

It is recommended to use Circuit A which regulates the current flowing through each LED rather than Circuit B. When driving LEDs with a constant voltage in Circuit B, the current through the LEDs may vary due to the variation in Forward Voltage (V_F) of the LEDs. In the worst case, some LED may be subjected to stress in the excess of the Absolute Maximum Rating.

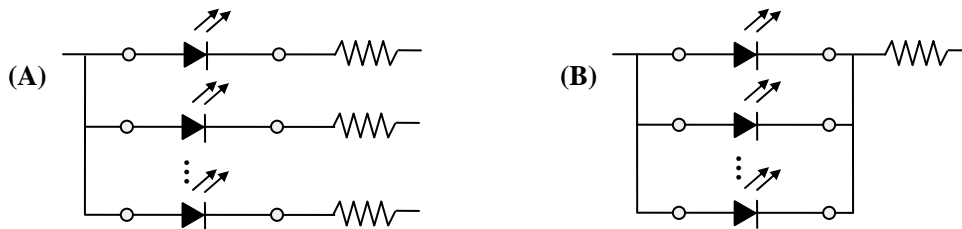

- LED LED

Thermal Design is paramount importance because heat generation may result in the Characteristics decline, such as brightness decrease, Color change and so on. Please consider the heat dissipation when making the system design.

4.

Reverse voltage protection

- LED LED
LED LED
LED 5V

In general, the reverse current of LED is very small, which won't affect the normal use of components. But when it is often suffered the reverse voltage which exceeds the limit of the component then it will be damaged.

