

# **SL-T2835IRC100-L210**

## **DATA SHEET**

SPEC. NO. : SZ19022005  
DATE : 2019/02/20  
REV. : A/0

Approved By:

Checked By:

Prepared By:

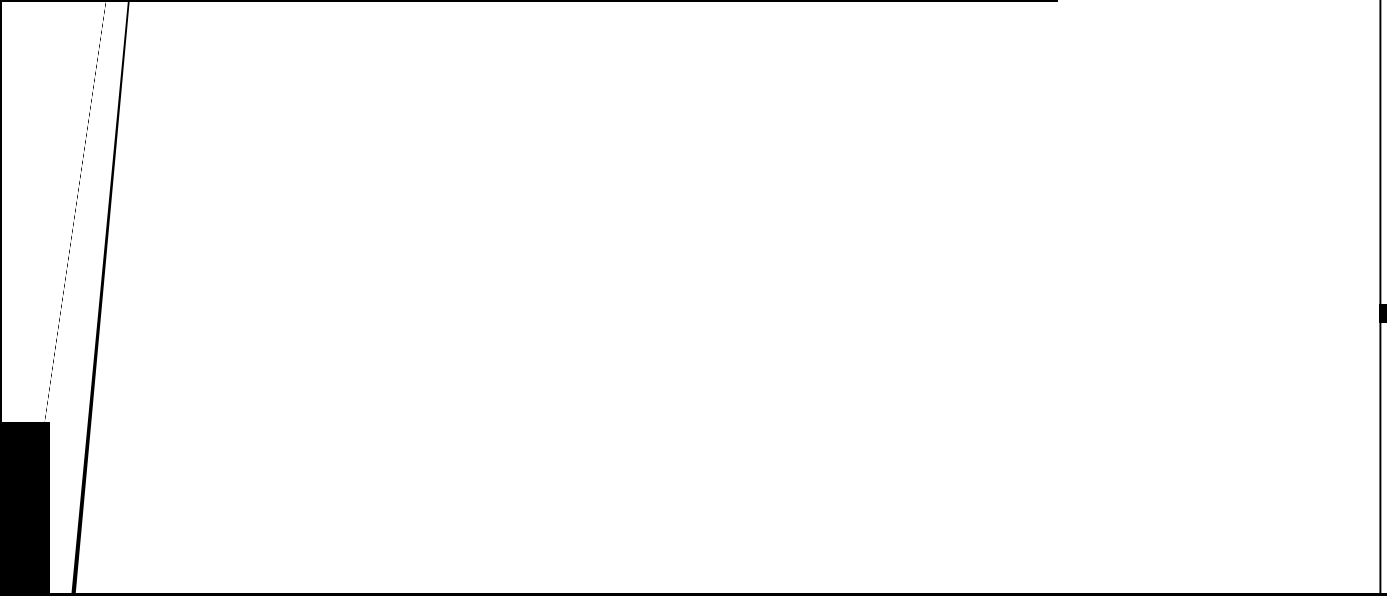
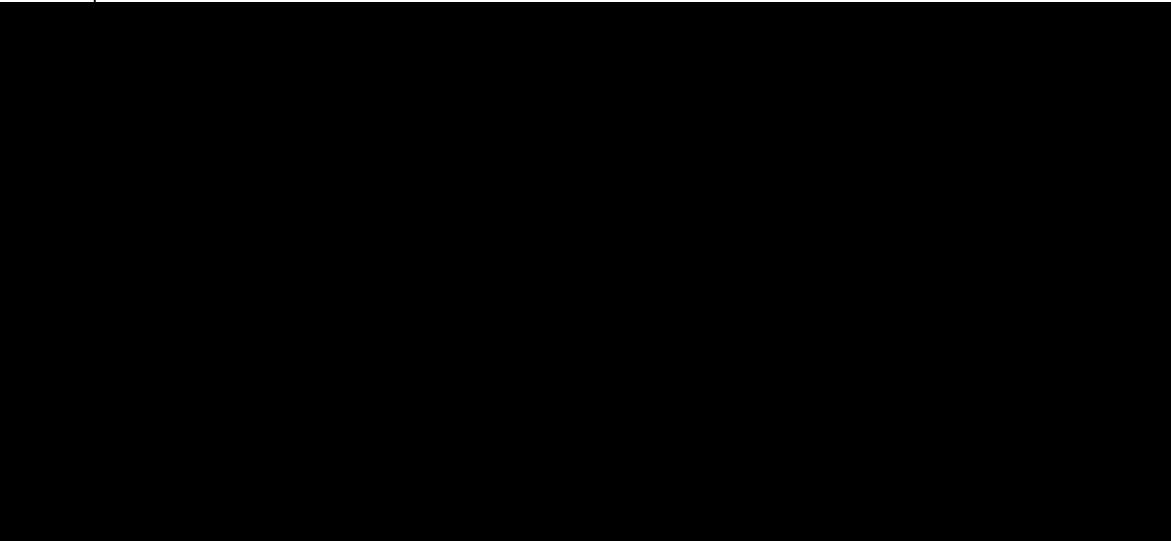

## Absolute Maximum Ratings at Ta=25

Parameter	MAX.	Unit
Power Dissipation	180	mW
Continuous Forward Current	25	mA
Peak Forward Current <sup>*2</sup>	100	mA
Reverse Voltage	5	V
Electrostatic Discharge (HBM) <sup>*3</sup>	4000	V
Moisture Sensitivity Level <sup>*1</sup>	5a	
Operating Temperature	-30 to + 85	
Storage Temperature	-40 to + 100	
Reflow Condition	260 MAX for 10 Seconds	

### 1. Storage

- (1). Storage requirements before vacuum bag opened: Temperature<30 , Humidity<65%RH;
- (2). Check air leakage and vacuum bag damage before opened. If there is any issue found, check the humidity indicator card immediately after bag opened:
  - a. If color changes on “10% circle” of the humidity indicator card only and not the circles of 20% and above, components can be used without additional handling;
  - b. If color changes on both 10% and 20% circles but not the circles of 30% and above, components must be dehumidified according to the conditions of bullet (5);
  - c. If color changes on 10%, 20%, and 30% circle or above, the product should be returned to the supplier for high temperature dehumidification;
- (3). After bag opened, manual soldering or reflow process must follow the following requirements:
  - a. Complete soldering / reflow within 24 hours;
  - b. Requirements of working environment: Temperature<30 , Humidity<60%RH;
- (4). If the working condition is outside (3)a requirement, the components must be dehumidified according to the conditions of bullet (5);
- (5). Low temperature dehumidification: temperature 60-65 , at least 24 hours;
- (6). Shelf life: 30 days. If it's over 30 days from the production date on the package label, the components must be dehumidified according to the condition of bullet (5). If customer is unable to dehumidify, return components to LIGHT for dehumidification.

### 2. Peak Forward Current:

Condition for is IFP pulse

### 3. Caution in ESD:

Static Electricity and surge damages the LED. It is recommend to use a wrist band or anti-electrostatic glove when handling the LED. All devices, equipment and machinery must be properly grounded.

### Electrical Optical Characteristics at Ta=25

Parameter	Symbol	Min.	Typ.	Max.	Unit	Test Condition
Radiant Flux	Po	25	27	29	mW/sr	I <sub>F</sub> =100mA * <sup>2</sup>
Viewing Angle(X)	1/2	---	60	---	Deg.	I <sub>F</sub> =100mA * <sup>1</sup>
Viewing Angle(Y)		---	60	---		
						I <sub>F</sub> =100mA
Spectral Line Half- Width		---	50	---	nm	I <sub>F</sub> =100mA
Forward Voltage	V <sub>F</sub>	1.3	1.5	1.8	V	I <sub>F</sub> =100mA
Reverse Current	I <sub>R</sub>	---	---	10	μA	V <sub>R</sub> =5V

**Note:**

1/2 is the off-axis angle at which the Radiant Intensity is half the axial Radiant Intensity.

2. The Po guarantee should be added ±15% tolerance.



L



**LIGHT ELECTRONICS CO., LTD.**

# LIGHT ELECTRELECTREL



## Label Explanation

<b>LIGHT</b>	
Light Electronics CO., LTD.	
MODEL NAME: _____	 LOT NO. : _____
QUANTITY: _____	
BIN: _____	
PACKING DATE: _____	
REMARKS: _____	

<b>LIGHT</b>	
Light Electronics CO., LTD.	
MODEL NAME: _____	 LOT NO. : _____
QUANTITY: _____	
BIN: _____	
PACKING DATE: _____	
CUSTOMER P/N: _____	

## Carrier Tape Specifications (Loaded Quantity: 2000pcs/reel)





## Suggest IR Reflow Condition For Lead Free

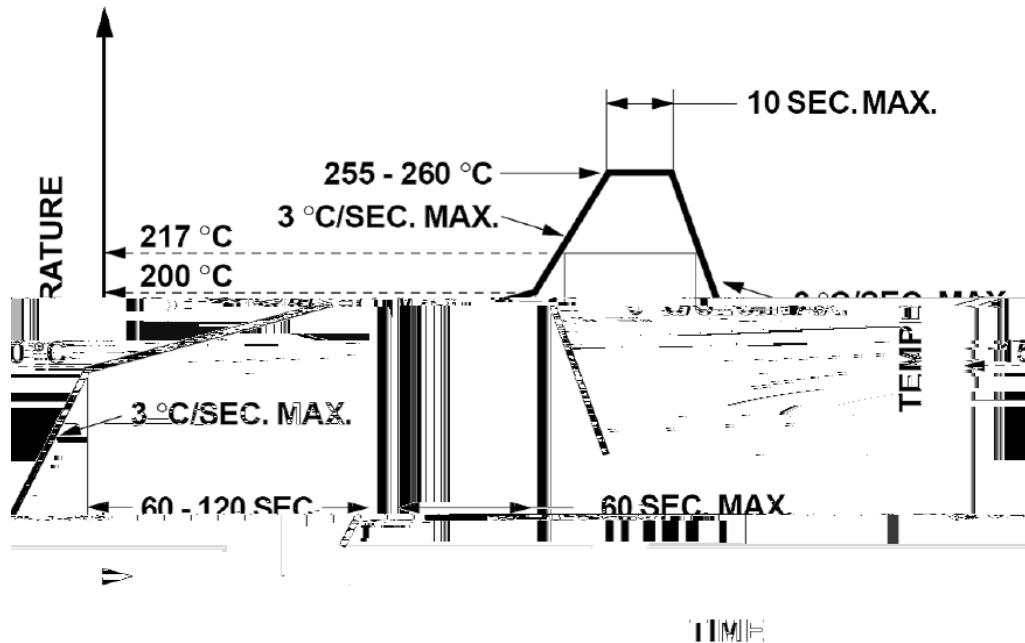

1. Reflow soldering should not be done more than two times.
2. When soldering, do not put stress on the LEDs during heating.

## Soldering iron

1. When hand soldering, the temperature of the iron must less than 300 for 3 seconds.
2. The hand solder should be done only once.

## Repairing

Repair should not be done after the LEDs have been soldered. When repairing is unavoidable, a double-head soldering iron should be used (as below figure). It should be confirmed beforehand whether the characteristics of LEDs will or will not be damaged by repairing.

