

LIGHT ELECTRONICS CO., LTD.

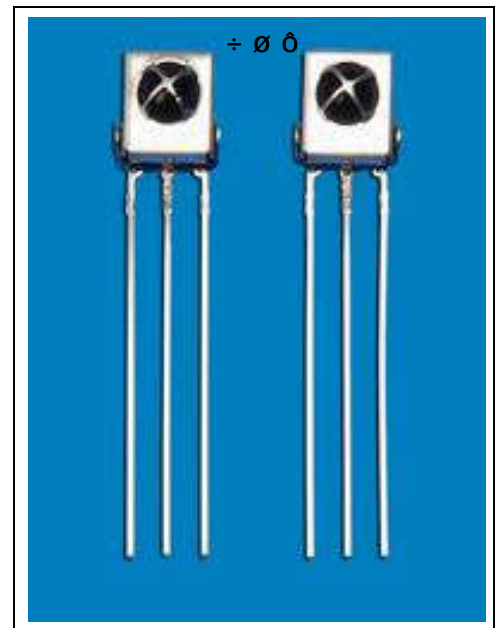

Part No.	LG-IRM2A438KSF3		
-----------------	------------------------	--	--

1 IRM2A438 SF3 PIN
IC
REACH ROHS



2 2.7-5.5V

3 TTL CMOS

3 : (MP3 MPã, ä ä æ ç è é ë ì í î é ê ï ð ñ ò

ã ó ô :

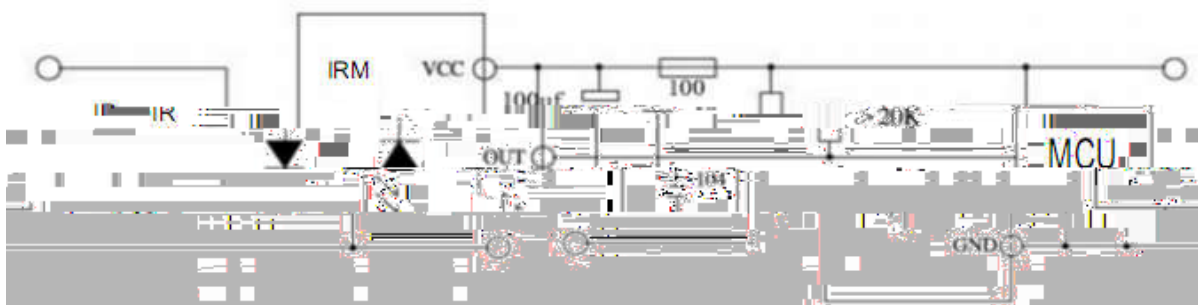

5 ó ô ô

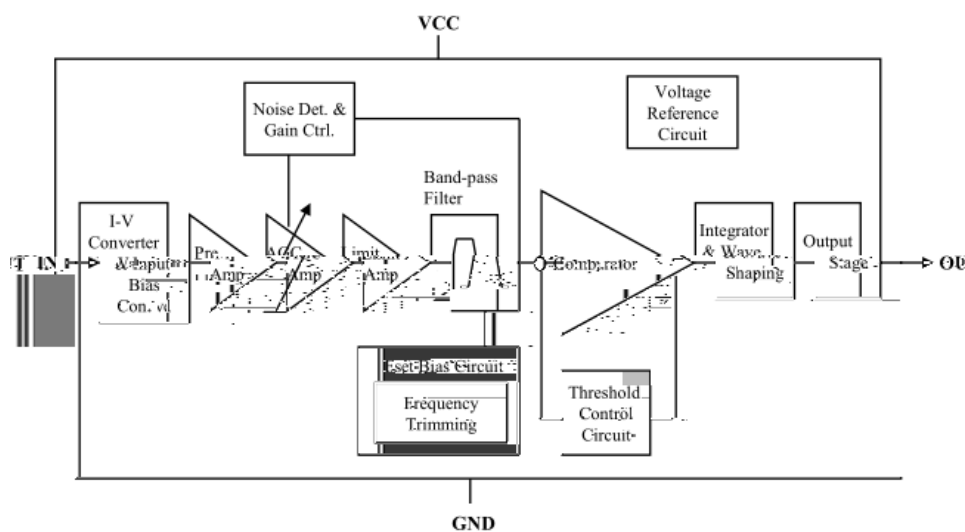

LIGHT ELECTRONICS CO., LTD.

LI

LIGHT ELECTRONICS CO., LTD.

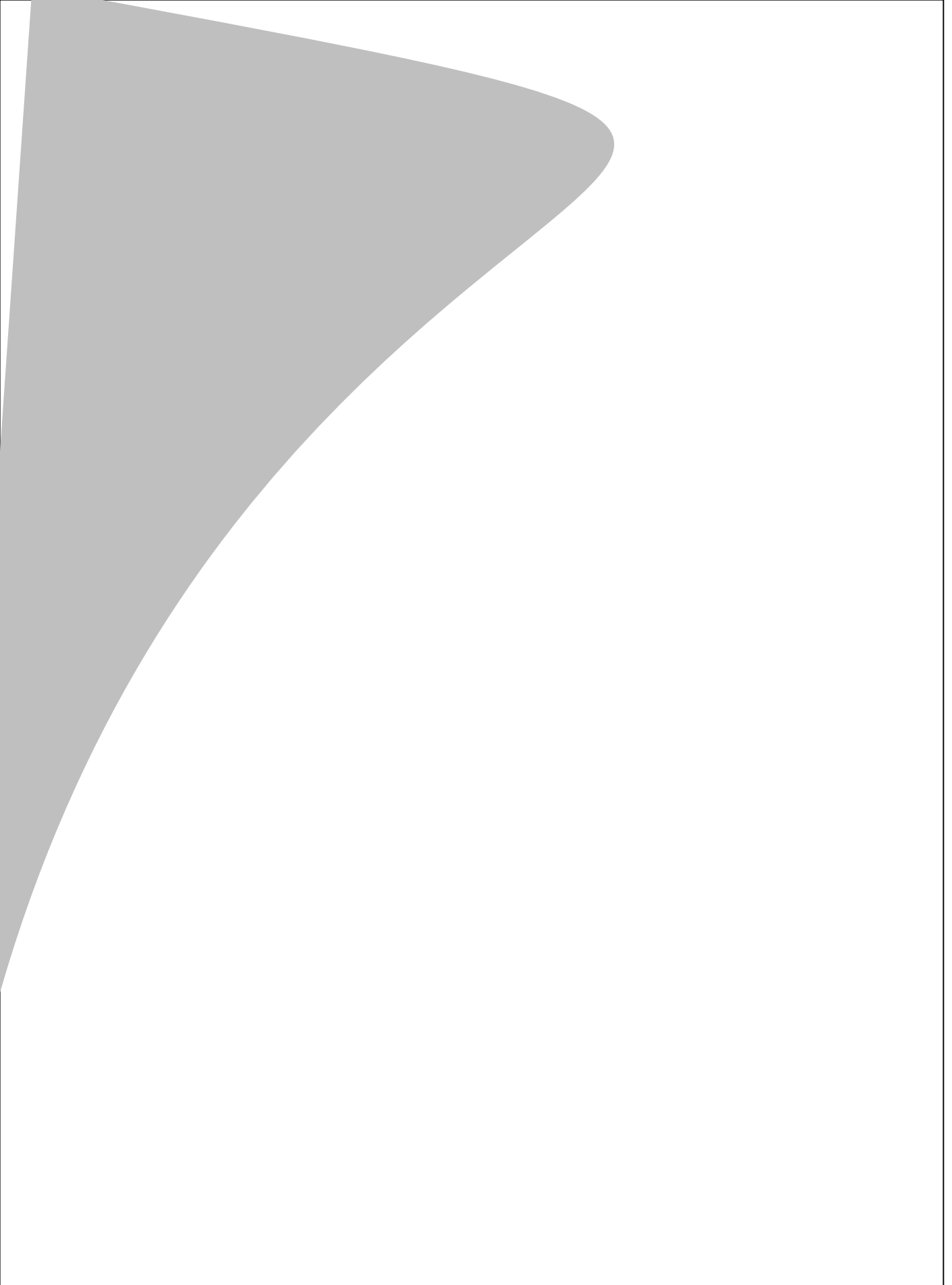

1ã

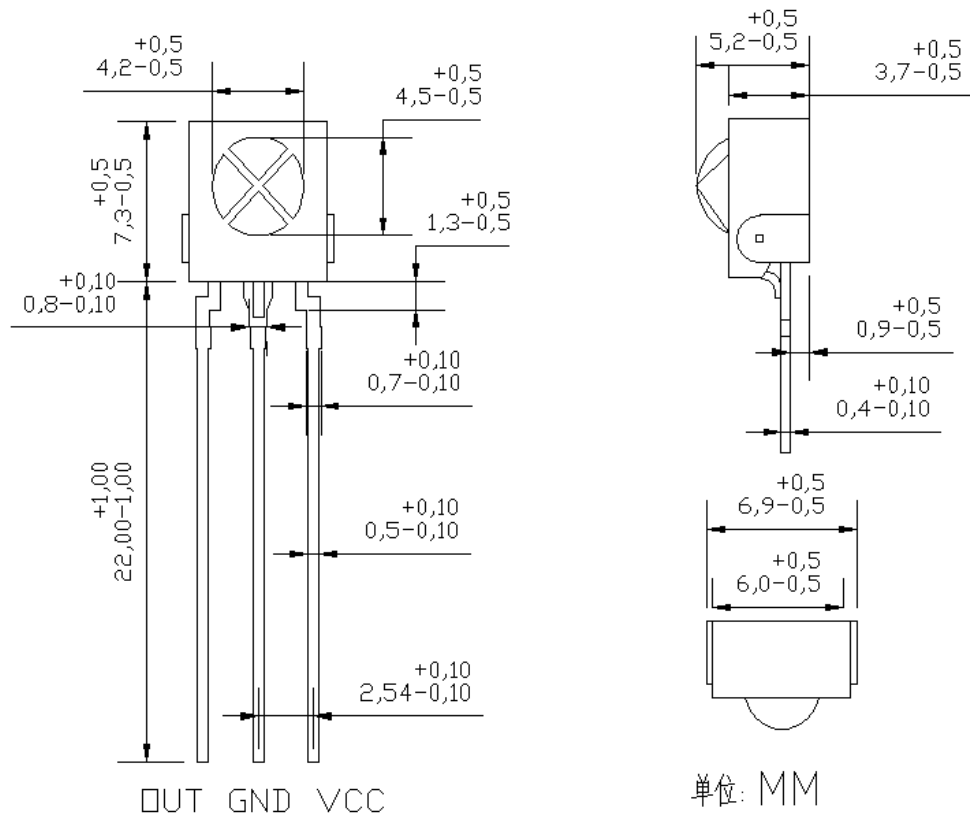

15

1è.

: 26pü 5 , ,

Ø 2 2 3 2

16.

1è. ë ô ï

ú 5pPCS

2è.

ô

ú 5pPCS

1p

ã

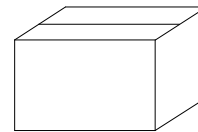
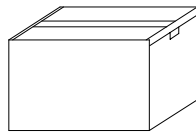
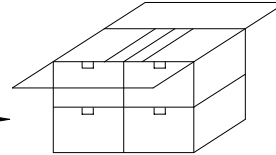
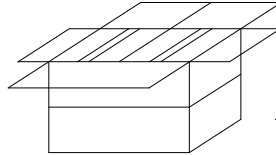
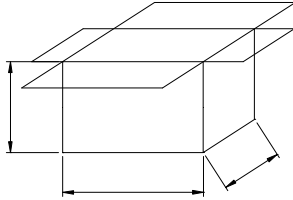
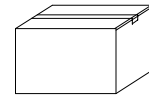
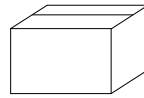
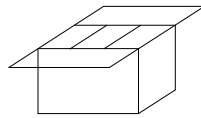
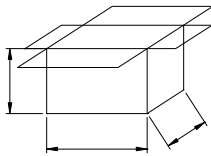
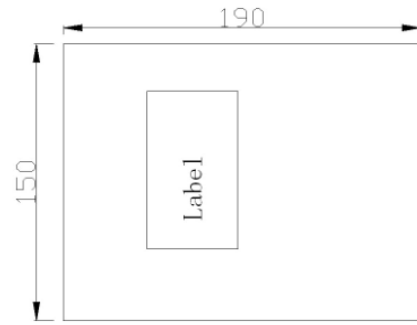

(pcs /)	(/)	(/)
500	10	4