

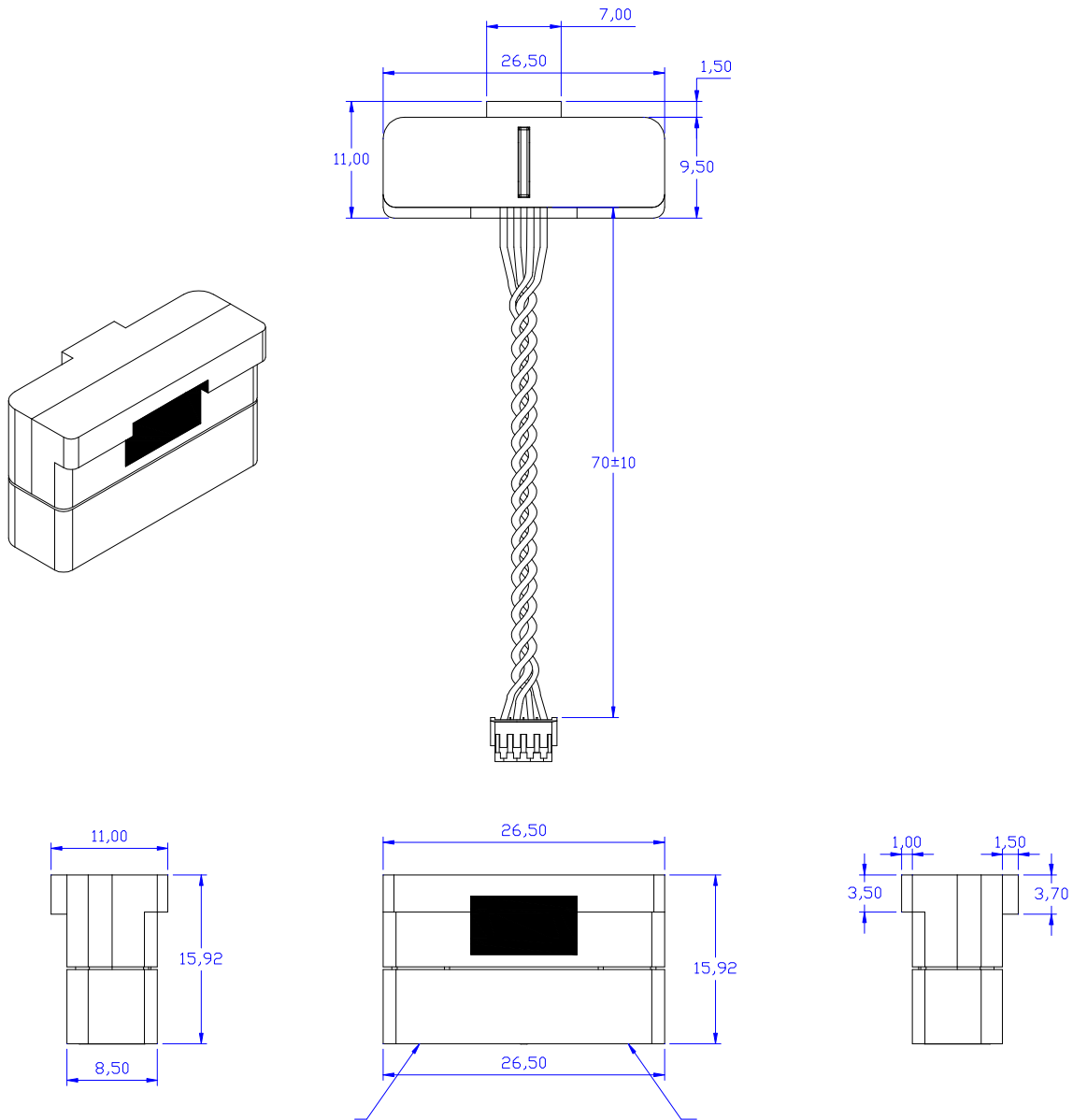

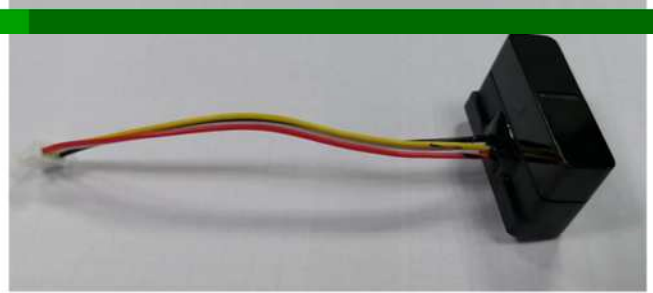





























—
—
—

--	--	--	--

Dimensions of Module



Notes:

1. All dimensions are in millimeters.
2. Tolerance is ± 0.50 mm unless otherwise noted.
3.                             
4. Specifications are subject to change without notice.

LIGHT ELECTRONICS CO., LTD.



