

LIGHT ELECTRONICS CO., LTD.



Part No.	LG-IRM2A438KSF3		
-----------------	------------------------	--	--

1

IRM2A438 SF3 PIN
 IC
 REACH RoHS

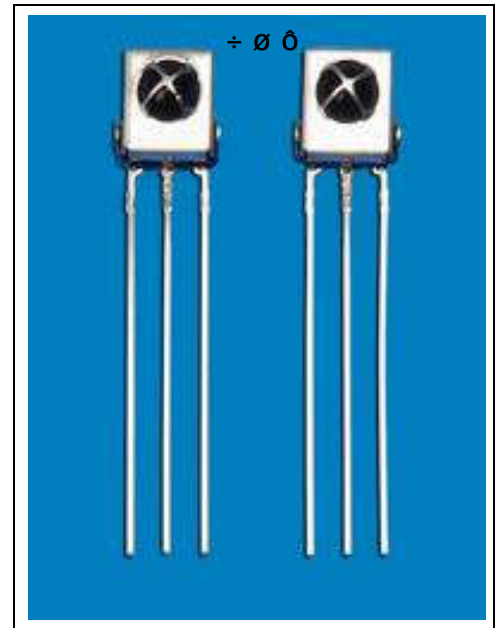

2

2.7-5.5V

3

TTL CMOS
 :
 (MP3 MP4, ä ä æ ç è
 é ê ë ì í î é ê í ç ï
 ð ñ ò

ã

ó ô :



5 ö ö ö

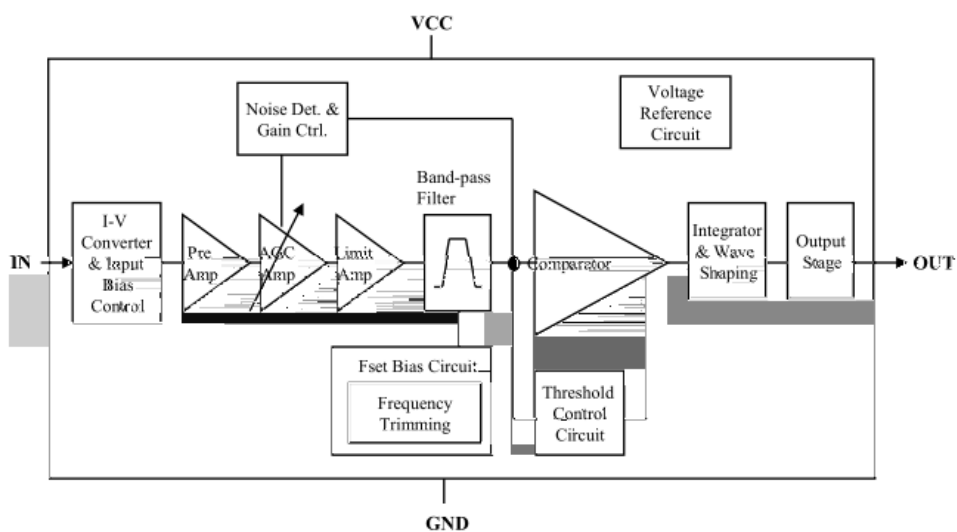

LIGHT ELECTRONICS CO., LTD.

L

LIGHT ELECTRONICS CO., LTD.

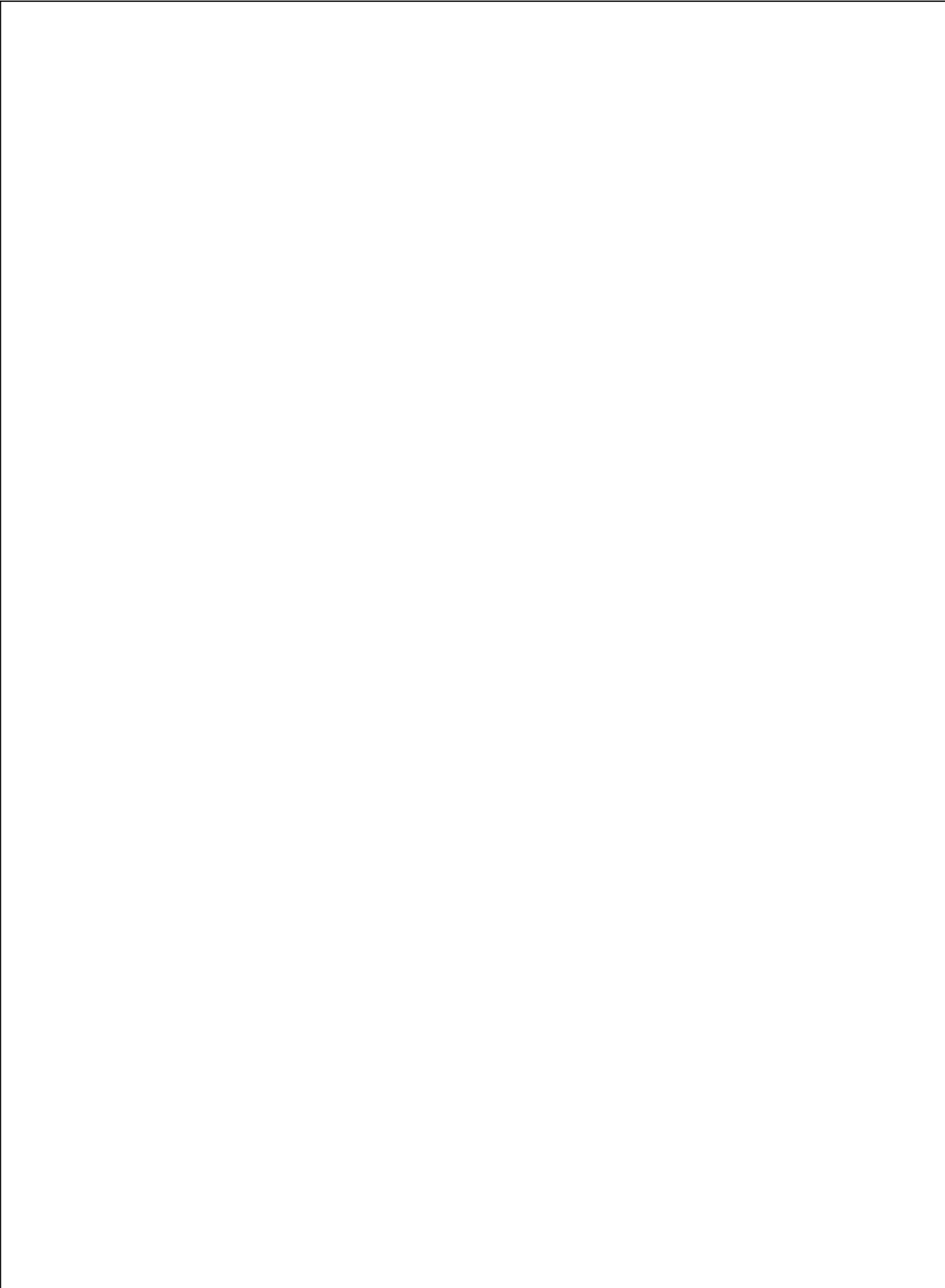

1ã

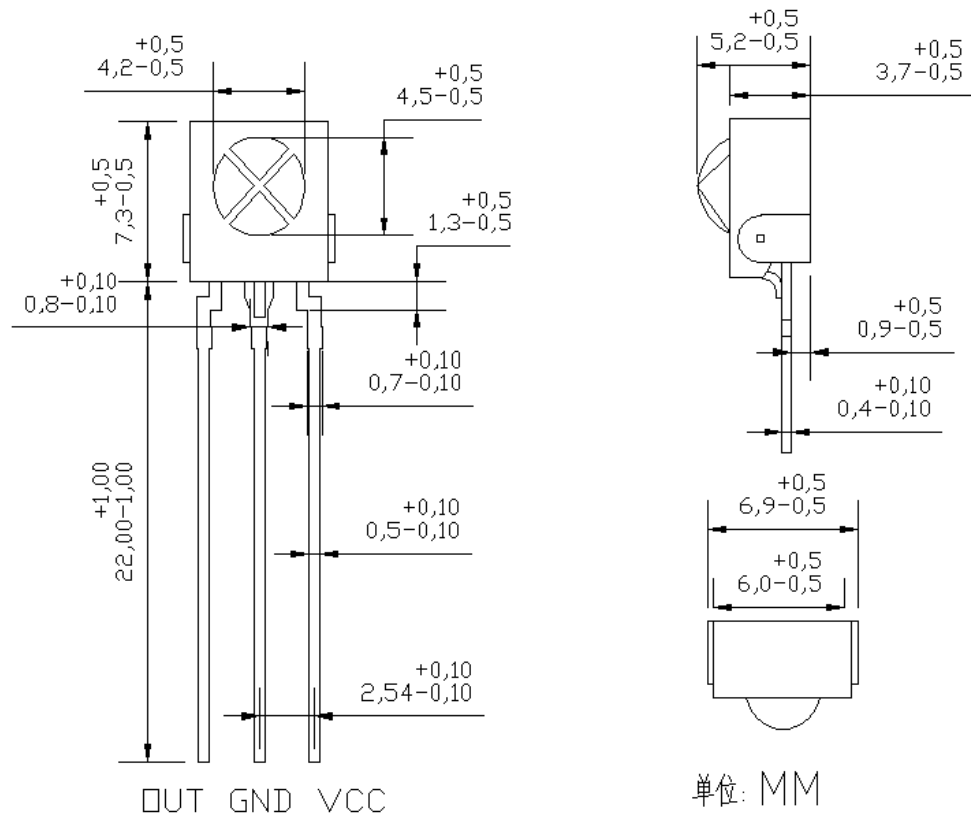

15

1è.

: 26pü 5

2

32

16.

1è. è ô ï

150mm× 190mm

ú 5pPCS

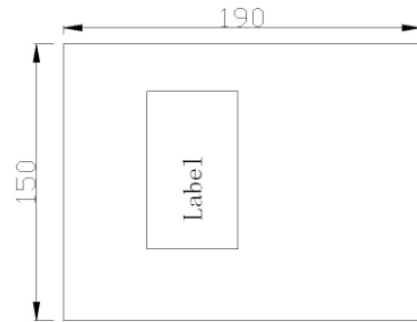

2è.

ô

ú 5pPCS

1p

ã

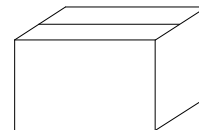
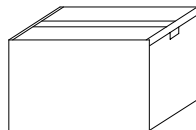
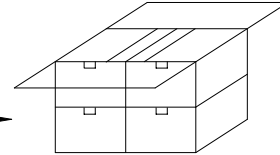
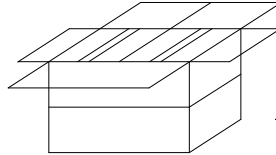
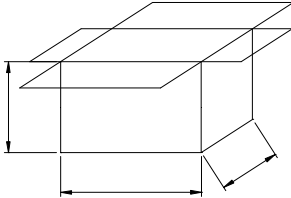
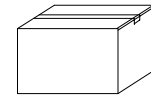
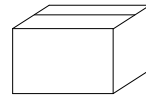
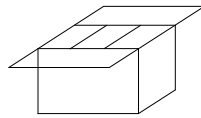
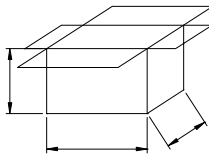

(pcs /)	(/)	(/)
500	10	4