

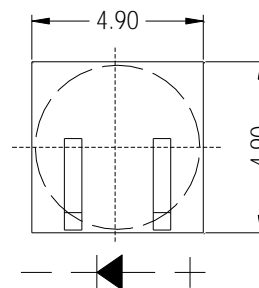

Features

- ◆ Pb free product RoHS compliant
- ◆ High Photo Sensitivity
- ◆ Reliable and rugged
- ◆ Long life solid state reliability
- ◆ Sensitivity angle: 55 °

Package Dimension

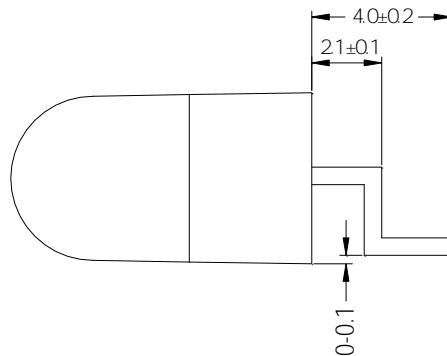
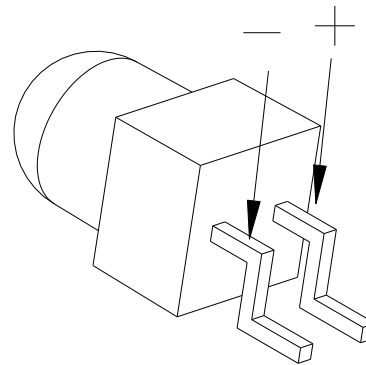
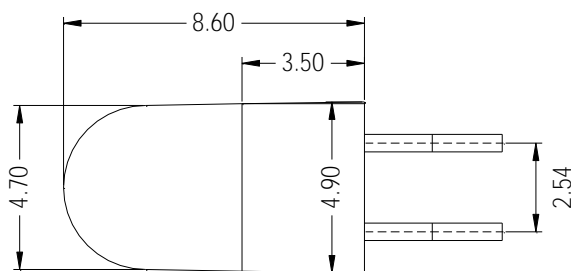

Part NO.	Chip Material	Lens Color
LG-05PD2D94Q-557K-B-T	Silicon	Black

Notes:

1. All dimensions are in millimeters.
2. Tolerance is ± 0.20 mm unless otherwise noted.
3. Protruded resin under flange is 1.0mm max.
4. Lead spacing is measured where the leads emerge from the package.
5. Specifications are subject to change without notice.



Typical Electrical / Optical Characteristics Curves (25°C Ambient Temperature Unless Otherwise Noted)

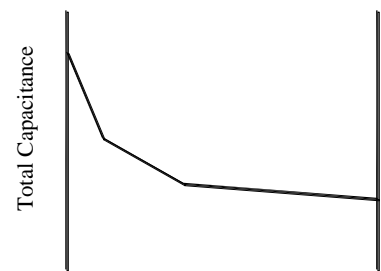
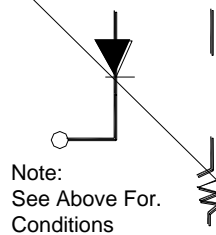
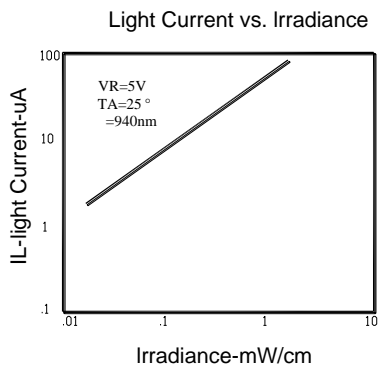
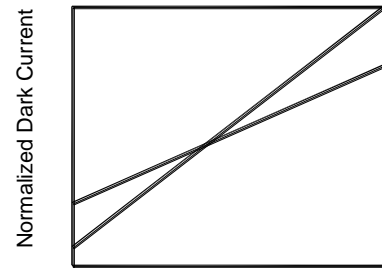
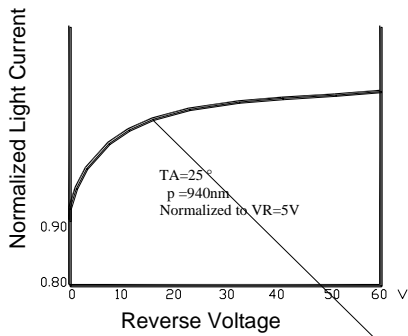
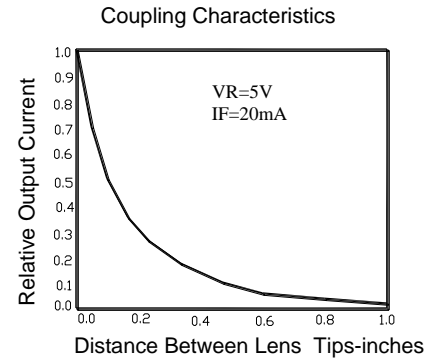
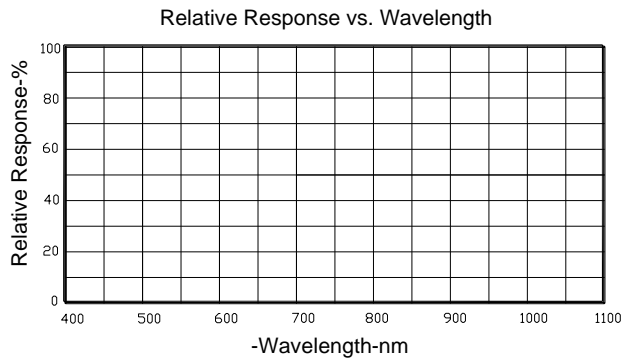

Package

Package Dimensions

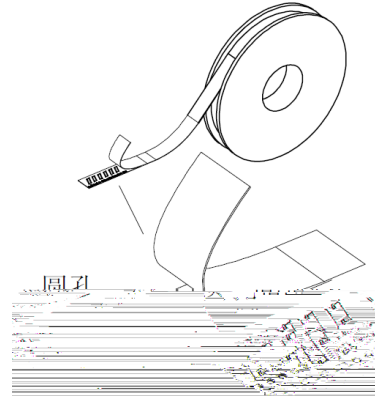
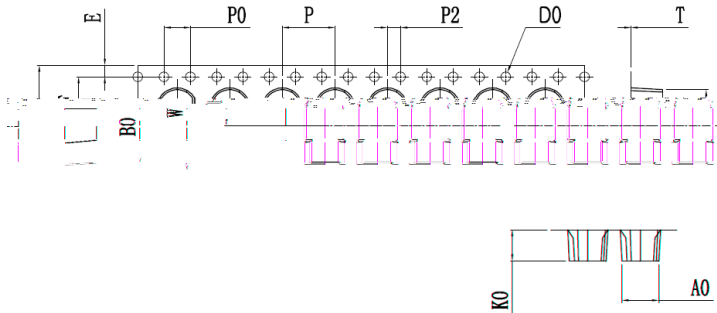

UNIT: mm

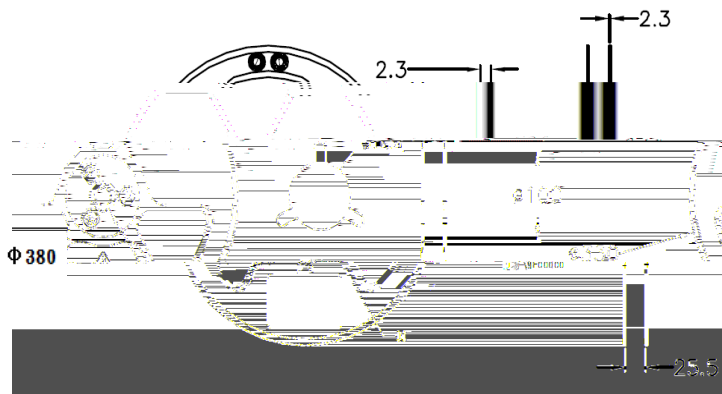

Item	Specification	
	Minum	Maximum
W	15.97	16.3
P	7.9	8.1
E	1.65	1.85
F	7.4	7.6
D	1.5	1.6
P0	3.9	4.1
P0x10	39.8	40.2
P2	1.9	2.1
A0	5.2	5.4
BO	10.6	10.8
KO	4.8	5.0

Notes:

- 1.All dimensions in millimeters.
- 2.All dimensions meet EIA-481-C requirements.
- 3.Cover tape by a heat sealing manner.

